

NPN Silicon RF Transistor*

- For low noise, high-gain amplifiers up to 2 GHz
- For linear broadband amplifiers
- $f_T = 8$ GHz, $F = 1$ dB at 900 MHz
- Pb-free (RoHS compliant) package¹⁾
- Qualified according AEC Q101

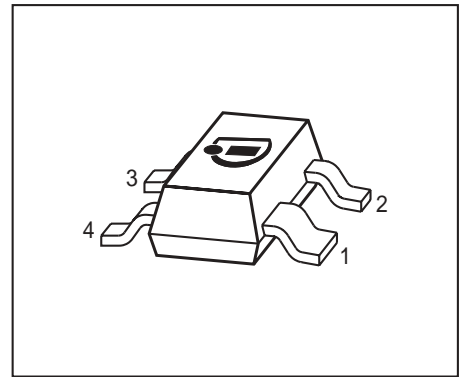

* Short term description



ESD (Electrostatic discharge) sensitive device, observe handling precaution!

Type	Marking	Pin Configuration						Package
BFP193	RCs	1 = C	2 = E	3 = B	4 = E	-	-	SOT143

Maximum Ratings

Parameter	Symbol	Value	Unit
Collector-emitter voltage	V_{CEO}	12	V
Collector-emitter voltage	V_{CES}	20	
Collector-base voltage	V_{CBO}	20	
Emitter-base voltage	V_{EBO}	2	
Collector current	I_C	80	mA
Base current	I_B	10	
Total power dissipation ²⁾ $T_S \leq 72^\circ\text{C}$	P_{tot}	580	mW
Junction temperature	T_j	150	°C
Ambient temperature	T_A	-65 ... 150	
Storage temperature	T_{stg}	-65 ... 150	

Thermal Resistance

Parameter	Symbol	Value	Unit
Junction - soldering point ³⁾	R_{thJS}	≤ 135	K/W

¹⁾Pb-containing package may be available upon special request

²⁾ T_S is measured on the collector lead at the soldering point to the pcb

³⁾For calculation of R_{thJA} please refer to Application Note Thermal Resistance

Electrical Characteristics at $T_A = 25^\circ\text{C}$, unless otherwise specified

Parameter	Symbol	Values			Unit
		min.	typ.	max.	
DC Characteristics					
Collector-emitter breakdown voltage $I_C = 1 \text{ mA}, I_B = 0$	$V_{(BR)CEO}$	12	-	-	V
Collector-emitter cutoff current $V_{CE} = 20 \text{ V}, V_{BE} = 0$	I_{CES}	-	-	100	μA
Collector-base cutoff current $V_{CB} = 10 \text{ V}, I_E = 0$	I_{CBO}	-	-	100	nA
Emitter-base cutoff current $V_{EB} = 1 \text{ V}, I_C = 0$	I_{EBO}	-	-	1	μA
DC current gain- $I_C = 30 \text{ mA}, V_{CE} = 8 \text{ V}, \text{ pulse measured}$	h_{FE}	70	100	140	-

Electrical Characteristics at $T_A = 25^\circ\text{C}$, unless otherwise specified

Parameter	Symbol	Values			Unit
		min.	typ.	max.	
AC Characteristics (verified by random sampling)					
Transition frequency $I_C = 50\text{ mA}$, $V_{CE} = 8\text{ V}$, $f = 500\text{ MHz}$	f_T	6	8	-	GHz
Collector-base capacitance $V_{CB} = 10\text{ V}$, $f = 1\text{ MHz}$, $V_{BE} = 0$, emitter grounded	C_{cb}	-	0.59	0.9	pF
Collector emitter capacitance $V_{CE} = 10\text{ V}$, $f = 1\text{ MHz}$, $V_{BE} = 0$, base grounded	C_{ce}	-	0.28	-	
Emitter-base capacitance $V_{EB} = 0.5\text{ V}$, $f = 1\text{ MHz}$, $V_{CB} = 0$, collector grounded	C_{eb}	-	2.25	-	
Noise figure $I_C = 10\text{ mA}$, $V_{CE} = 8\text{ V}$, $Z_S = Z_{Sopt}$, $f = 900\text{ MHz}$ $I_C = 10\text{ mA}$, $V_{CE} = 8\text{ V}$, $Z_S = Z_{Sopt}$, $f = 1.8\text{ GHz}$	F	-	1	-	dB
		-	1.6	-	
Power gain, maximum available ¹⁾ $I_C = 30\text{ mA}$, $V_{CE} = 8\text{ V}$, $Z_S = Z_{Sopt}$, $Z_L = Z_{Lopt}$, $f = 900\text{ MHz}$ $I_C = 30\text{ mA}$, $V_{CE} = 8\text{ V}$, $Z_S = Z_{Sopt}$, $Z_L = Z_{Lopt}$, $f = 1.8\text{ GHz}$	G_{ma}	-	18	-	
		-	12	-	
Transducer gain $I_C = 30\text{ mA}$, $V_{CE} = 8\text{ V}$, $Z_S = Z_L = 50\Omega$, $f = 900\text{ MHz}$ $I_C = 30\text{ mA}$, $V_{CE} = 8\text{ V}$, $Z_S = Z_L = 50\Omega$, $f = 1.8\text{ GHz}$	$ S_{21e} ^2$	-	14.5	-	dB
		-	8.5	-	

¹⁾ $G_{ma} = |S_{21} / S_{12}| (k - (k^2 - 1)^{1/2})$

SPICE Parameter (Gummel-Poon Model, Berkley-SPICE 2G.6 Syntax):
Transistor Chip Data:

IS =	0.2738	fA	BF =	125	-	NF =	0.95341	-
VAF =	24	V	IKF =	0.26949	A	ISE =	10.627	fA
NE =	1.935	-	BR =	14.267	-	NR =	1.4289	-
VAR =	3.8742	V	IKR =	0.037925	A	ISC =	0.037409	fA
NC =	0.94371	-	RB =	1.8368	Ω	IRB =	0.91763	mA
RBM =	1	Ω	RE =	0.76534	-	RC =	0.11938	Ω
CJE =	1.1824	fF	VJE =	0.70276	V	MJE =	0.48654	-
TF =	18.828	ps	XTF =	0.69477	-	VTF =	0.8	V
ITF =	0.96893	mA	PTF =	0	deg	CJC =	935.03	fF
VJC =	1.1828	V	MJC =	0.30002	-	XCJC =	0.053563	-
TR =	1.0037	ns	CJS =	0	fF	VJS =	0.75	V
MJS =	0	-	NK =	0	-	EG =	1.11	eV
XTI =	3	-	FC =	0.72063		TNOM	300	K

All parameters are ready to use, no scaling is necessary. Extracted on behalf of Infineon Technologies AG by: Institut für Mobil- und Satellitentechnik (IMST)

Package Equivalent Circuit:

L_{BI} =	0.84	nH
L_{BO} =	0.65	nH
L_{EI} =	0.31	nH
L_{EO} =	0.14	nH
L_{CI} =	0.07	nH
L_{CO} =	0.42	nH
C_{BE} =	145	fF
C_{CB} =	19	fF
C_{CE} =	281	fF

Valid up to 6GHz

For examples and ready to use parameters please contact your local Infineon Technologies distributor or sales office to obtain a Infineon Technologies CD-ROM or see Internet: <http://www.infineon.com>

Total power dissipation $P_{tot} = f(T_S)$

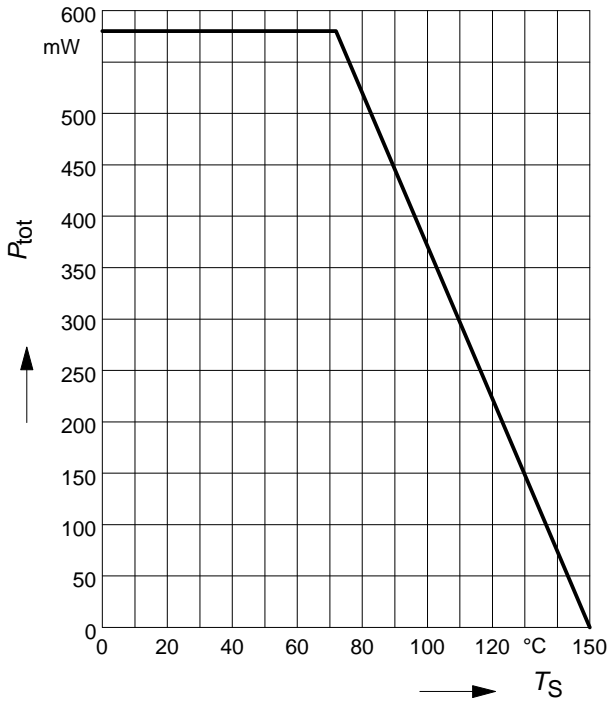

Permissible Pulse Load $R_{thJS} = f(t_p)$

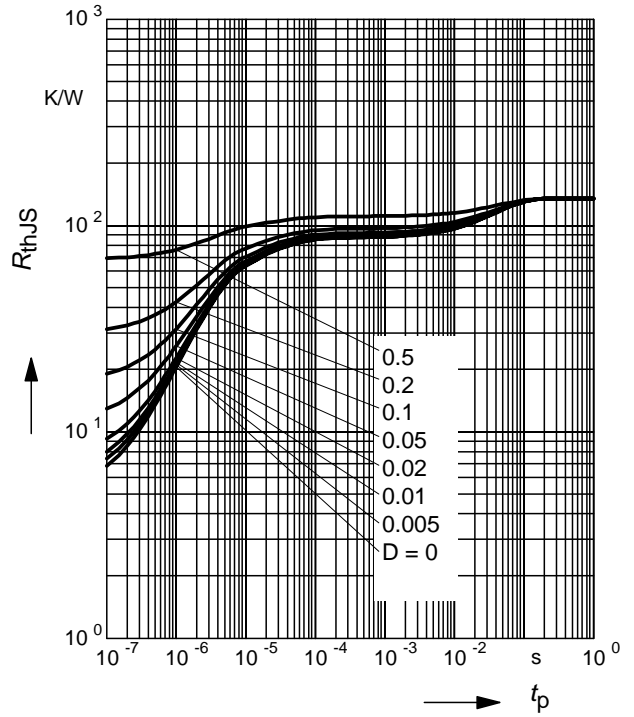

Permissible Pulse Load

$P_{totmax}/P_{totDC} = f(t_p)$

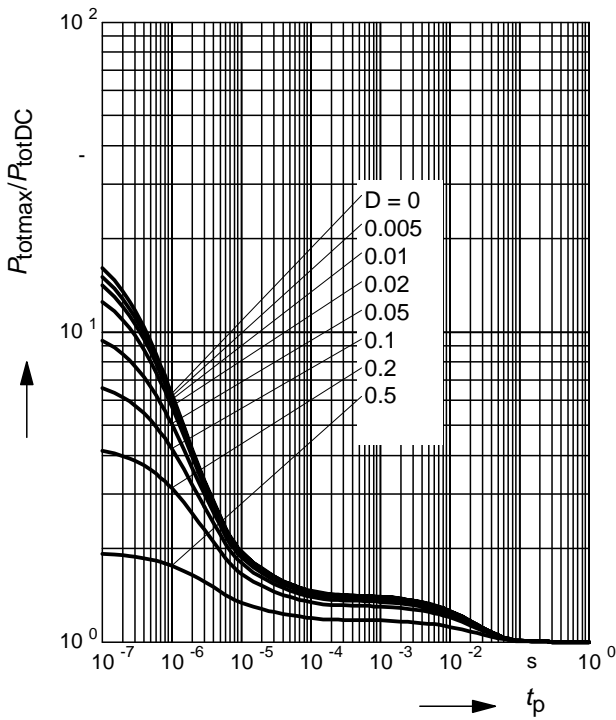

Package Outline

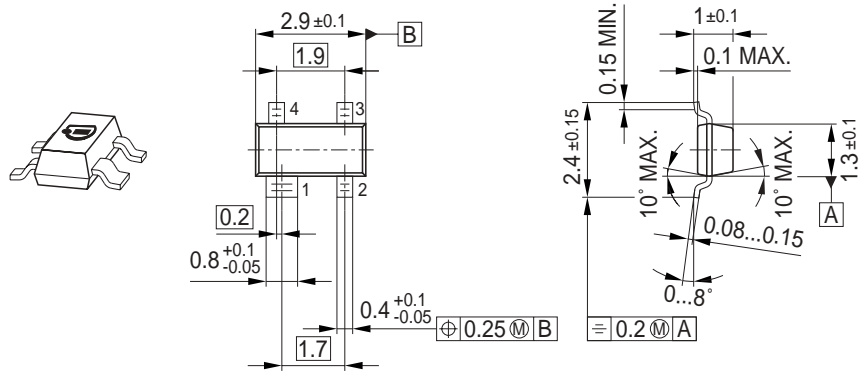

Foot Print

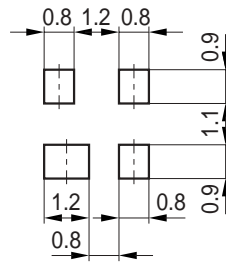

Marking Layout (Example)

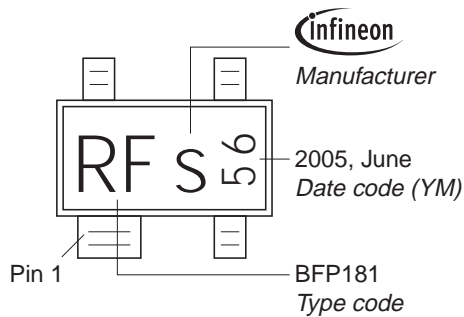

Standard Packing

Reel \varnothing 180 mm = 3.000 Pieces/Reel
 Reel \varnothing 330 mm = 10.000 Pieces/Reel



Edition 2006-02-01

Published by

Infineon Technologies AG

81726 München, Germany

© Infineon Technologies AG 2007.

All Rights Reserved.

Attention please!

The information given in this dokument shall in no event be regarded as a guarantee of conditions or characteristics ("Beschaffenheitsgarantie"). With respect to any examples or hints given herein, any typical values stated herein and/or any information regarding the application of the device, Infineon Technologies hereby disclaims any and all warranties and liabilities of any kind, including without limitation warranties of non-infringement of intellectual property rights of any third party.

Information

For further information on technology, delivery terms and conditions and prices please contact your nearest Infineon Technologies Office (www.infineon.com).

Warnings

Due to technical requirements components may contain dangerous substances. For information on the types in question please contact your nearest Infineon Technologies Office.

Infineon Technologies Components may only be used in life-support devices or systems with the express written approval of Infineon Technologies, if a failure of such components can reasonably be expected to cause the failure of that life-support device or system, or to affect the safety or effectiveness of that device or system.

Life support devices or systems are intended to be implanted in the human body, or to support and/or maintain and sustain and/or protect human life. If they fail, it is reasonable to assume that the health of the user or other persons may be endangered.